



**PYLONTECH**



# Rechargeable Li-ion Battery

## US2000 Operation Manual

### UL version

Information Version: V1.0  
UL20BPSV0901



This manual introduces US2000 from Pylontech. Please read this manual before you to install the battery and follow the instruction carefully during the installation process. Any confusion, please contact Pylontech immediately for advice and clarification.

<b>1. Safety / Sécurité</b>	<b>1</b>
<b>2. Introduction</b>	<b>8</b>
2.1 Features	8
2.2 Specification	9
2.3 Equipment interface instruction	11
Definition of RJ45 Port Pin	13
<b>3. Safe handling of lithium batteries guide</b>	<b>15</b>
3.1 Schematic diagram of solution	15
3.2 Danger label	15
3.3 Tools	16
3.4 Safety gear	16
<b>4. Installation and operation</b>	<b>17</b>
4.1 Package items	17
4.2 Installation location	18
4.3 Grounding	20
4.4 put into cabinet or racks	21
4.5 Put into bracket	23
4.6 power on	26
4.7 Power off	28
4.8 Multi-group mode	28
<b>5. Trouble shooting.</b>	<b>31</b>
<b>6. Emergency Situations</b>	<b>33</b>
<b>7. Remarks</b>	<b>35</b>

# 1. Safety / Sécurité

The US2000 is operated by authorized person only. Read all safety instructions carefully prior to any work and observe them at all times when working on with the system.

*US2000 opéré uniquement par le personnel autorisé. Lisez attentivement toutes les instructions de sécurité avant tout travail et respectez-les à tout moment lorsque vous travaillez avec le système*

Incorrect operation or work may cause:

- 1) Injury or death to the operator or a third party
- 2) Damage to the system hardware and other properties belonging to the operator or a third party.

*Une opération ou un travail incorrect peut causer:*

- 1) *blessure ou mort à l'opérateur ou à un tiers;*
- 2) *Dompage au matériel du système et à d'autres propriétés appartenant à l'opérateur ou à un tiers.*







Qualified personnel must have the following skills:

- 1) Training in the installation and commissioning of the electrical system, as well as the dealing with hazards
- 2) Knowledge of the manual and other related documents
- 3) knowledge of the local regulations and directives.

*Le personnel qualifié doit avoir les compétences suivantes:*

- 1) *Formation en matière d'installation et de mise en service du système électrique, et de gestion des risques;*
- 2) *Connaissance du manuel et d'autres documents concerné;*
- 3) *Connaissance des réglementations et directives locales.*

## Symbol /Symbole

	<p>Danger <i>Danger</i></p>	<p>Lethal voltage! <i>Tension mortelle!</i>          Battery strings will produce high voltage DC power and can cause a lethal voltage and an electric shock.  <i>La batterie produira un courant continu à haute tension et peuvent provoquer une tension mortelle et un choc électrique.</i>          Only qualified person can perform the wiring of the battery strings.  <i>Seule le personnel qualifié peut effectuer le câblage de la batterie.</i></p>
	<p>Warning <i>Avertissement</i></p>	<p>Risk of battery system damage or personal injury  <i>Risque d'endommagement du système de batterie ou de blessure corporelle</i>          DO not pull out the connectors while the system is working!  <i>NE PAS debrancher les connecteurs lorsque le système fonctionne!</i>          De-energize from all multiple power sources and verify that there is no voltage.  <i>Mettez hors tension toutes les sources d'alimentation et vérifiez qu'il n'y a pas de tension.</i></p>
	<p>Caution <i>Attention</i></p>	<p>Risk of battery system failure or life cycle reduces.  <i>Risque de défaillance ou de réduction de durée de vie du système de batterie.</i></p>
	<p>Read the product and operation manual before operating the battery system!  <i>Lisez le manuel du produit avant d'utiliser le système de batterie!</i></p>	
<div style="display: flex; justify-content: space-around; align-items: center;"> <div style="text-align: center;">   <b>Li-ion</b> </div> <div style="text-align: center;">    </div> </div>		



## Danger

Batteries deliver electric power, resulting in burns or a fire hazard when they are short circuited, or wrongly installed.

*Les piles fournissent de l'énergie électrique, ce qui entraîne des brûlures ou un risque d'incendie lorsqu'elles sont court-circuitées ou mal installées.*

Lethal voltages are present in the battery terminals and cables. Severe injuries or death may occur if the cables and terminals are touched.

*Des tensions mortelles sont présentes dans les bornes et les câbles de la batterie. Des blessures graves, voire mortelles, peuvent survenir si les câbles et les bornes sont touchés*

Do not connect battery with PV solar wiring directly

*Ne pas connecter directement la batterie avec le câblage solaire PV*

It is prohibited to connect the battery and AC power directly

*Il est interdit de connecter directement la batterie avec l'alimentation CA*

In case of fire, only dry powder fire extinguisher can be used, liquid fire extinguishers are prohibited

*En cas d'incendie, seul un extincteur à poudre sèche peut être utilisé, les extincteurs à liquide sont interdits*



## Warning

Do not open or deform the battery module; It is prohibited to disassemble the battery (QC tab removed or damaged)

*Ne pas ouvrir ou déformer le module de batterie; Il est interdit de démonter la batterie (languette QC retirée ou endommagée)*

For battery installation, the installer shall refer to NFPA70 standard for operation.

*Lors du montage extérieur de la batterie, le montage doit être réalisé conformément à la Norme NFPA70*

Do not expose cable outside

*Ne pas exposer le câble à l'extérieur*

Any foreign object is prohibited to insert into any part of battery.

*Il est interdit d'insérer aucun objet étranger dans aucune partie de la batterie*

Do not expose battery to flammable or harsh chemicals or vapors; Keep the battery away from water and fire.

*Ne pas exposer la batterie à des produits chimiques inflammables ou agressifs ou vapeurs ; Gardez la batterie loin de l'eau et du feu.*

The embedded BMS in the battery is designed for 48VDC, please DO NOT connect battery in series



## Caution

Improper settings or maintenance can permanently damage the battery. Incorrect inverter parameters will lead to the premature aging of battery  
*Le réglage ou la maintenance incorrecte peuvent endommager en permanence la batterie. Les paramètres de l'inverseur incorrects entraîneront un vieillissement prématuré de la batterie.*

Battery needs to be recharged within 12 hours, after fully discharged  
*La batterie doit être rechargée dans les 12 heures, après avoir été complètement déchargée*

Do not use cleaning solvents to clean battery  
*Ne pas utiliser des solvants de nettoyage pour nettoyer la batterie*

Do not paint any part of battery, include any internal or external components  
*Ne pas peindre aucune partie de la batterie, y compris les composants internes ou externes*

Please contact the supplier within 24 hours if there is something abnormal. The warranty claims are excluded for direct or indirect damage due to items above.

After unpacking, please check product and packing list first, if product is damaged or lack of parts, please contact with the local retailer

Please ensure the electrical parameters of battery system are compatible to related equipment, such as charger, inverter or load.

Make sure the settings on inverter are correct for US2000.

If possible, check the communication between battery system and inverter is working normally





### Caution before connecting

Before installation, be sure to cut off the grid power and make sure the battery is in the turned-off mode

*Avant l'installation, assurez-vous de couper l'alimentation du réseau et assurez-vous que la batterie est éteinte*

Wiring must be correct, do not mistake the positive and negative cables, and ensure no short circuit with the external device

*Le câblage doit être correct, ne pas confondre les câbles positif et négatif, et éviter tout court-circuit avec l'appareil externe*

Battery system must be well grounding and the resistance must be less than  $0.1\Omega$

*Le système de batterie doit être bien mis à la terre et la résistance doit être inférieure à  $0.1\Omega$*



## Caution in using

If the battery system needs to be moved or repaired, the power must be cut off and the battery is completely shut down

*Si la batterie doit être déplacée ou réparée, l'alimentation doit être coupée et la batterie doit être complètement arrêtée*

It is prohibited to connect the battery with different type of battery

*Il est interdit de connecter la batterie à une batterie de différent type*

Please do not open, repair or disassemble the battery except staffs from Pylontech or authorized by Pylontech. We do not undertake any consequences or related responsibility which because of violation of safety operation or violating of design, production and equipment safety standards

*Veillez ne pas ouvrir, réparer ou démonter la batterie, à l'exception du personnel de Pylontech ou autorisé par Pylontech. Nous n'assumons aucune conséquence ou responsabilité connexe qui, en raison d'une violation des opérations de sécurité ou d'une violation des normes de conception, de production et de sécurité de l'équipement.*

## **2. Introduction**

US2000 lithium iron phosphate battery is the energy storage products developed and produced by Pylontech, it can be used to support reliable power for various types of equipment and systems.

US2000 has built-in BMS battery management system, which can manage and monitor cells information including voltage, current and temperature.

### **2.1 Features**

- 1) The module is non-toxic, non-pollution and environmentally friendly
- 2) Cathode material is made from  $\text{LiFePO}_4$  with safety performance and long cycle life
- 3) Battery management system (BMS) has protection functions including over-discharge, over-charge, over-current and high/low temperature
- 4) The system can automatically manage charge and discharge state and balance voltage of each cell
- 5) Flexible configuration, multiple battery modules can be in parallel for expanding capacity and power
- 6) Adopted self-cooling mode rapidly reduced system entire noise
- 7) The module has less self-discharge, up to 6 months without charging it on shelf, no memory effect, excellent performance of shallow charge and discharge
- 8) Small size and light weight, standard of 19-inch embedded designed module is comfortable for installation and maintenance.

## 2.2 Specification

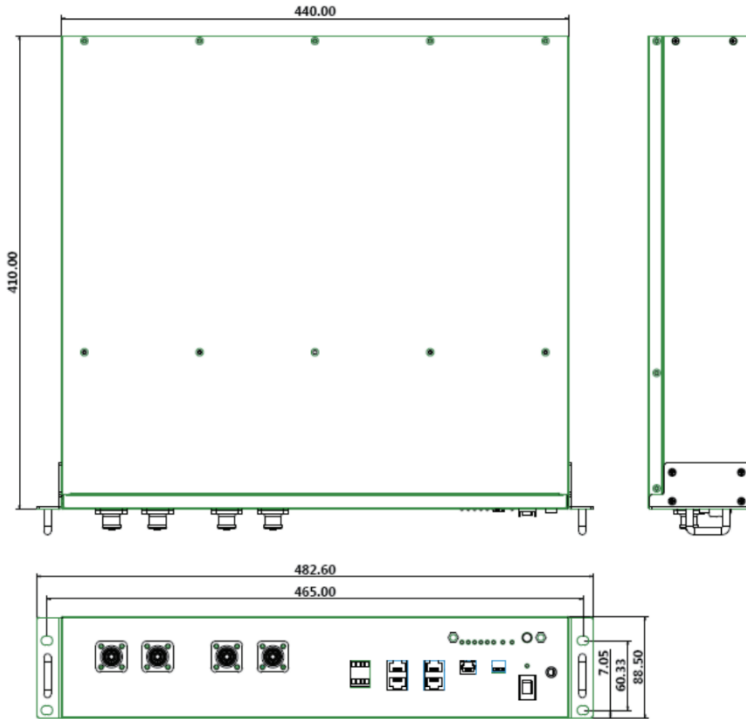

Basic Parameters	US2000
Nominal Voltage (V)	48
Nominal Capacity (Wh)	2400
Usable Capacity (Wh)	2160
Dimension (mm)	440*410*89
Weight (Kg)	22.5
Discharge Voltage (V)	44.5 ~ 53.5
Charge Voltage (V)	52.5 ~ 53.5
Recommend Charge/Discharge Current (A)	25
Max. Charge/Discharge Current (A)	50
Peak Charge/Discharge Current (A)	90A@15sec
Communication	RS485, CAN

Depth of discharge (%)	90
Configuration (max. in 1 battery group)	8pcs
Working Temperature	0°C~50°C Charge
	-10°C~50°C Discharge
Shelf Temperature	-20°C~60°C
Protective class	I
IP rating of enclosure	IP20
Humidity	5 ~ 95%(RH)
Certification	TÜV / CE / UN38.3/UL
Design life	10+ Years (25°C/77°F)
Cycle Life	>4,500 25°C
Reference to standards	IEC62619, UL1973, UL1642, IEC61000-6-2, IEC61000-6-3, UN38.3

## 2.3 Equipment interface instruction

### US2000 Product Front Interface

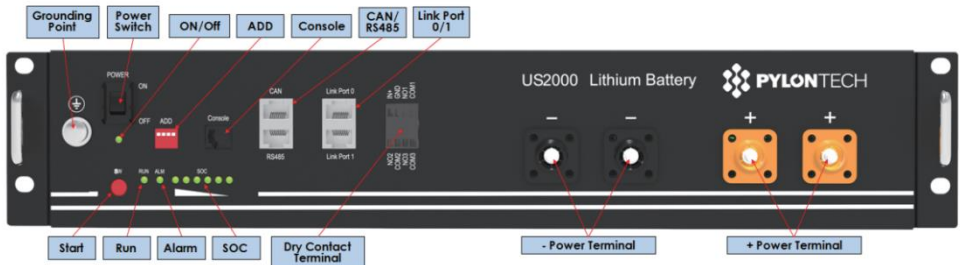

#### Power Switch

ON: ready to turn on.

OFF: power off. For storage or shipping.

#### Start

Turn on: press more than 0.5s to start the battery module

Turn off: press more than 0.5s to turn off the battery.

#### RUN

Green LED lighting to show the battery running status

#### Alarm

Red LED flashing to show the battery has alarm; lighting to show the battery is under protection.

#### SOC

6 green LEDs to show the battery's current capacity.

#### ADD Switch

Dip1: RS485 baud rate 1: 9600; 0: 115200. The settings will be active only after restart the battery.

Dip2~4, address of multiple battery group connection. Change the setting of master battery ONLY.

Dip2	Dip3	Dip4	Group address number
0	0	0	0: single battery group
1	0	0	1: 1 <sup>st</sup> battery group
0	1	0	2: 2 <sup>nd</sup> battery group
1	1	0	3: 3 <sup>rd</sup> battery group
0	0	1	4: 4 <sup>th</sup> battery group
1	0	1	5: 5 <sup>th</sup> battery group
0	1	1	6: 6 <sup>th</sup> battery group
1	1	1	7: 7 <sup>th</sup> battery group

### Console

For manufacturer or professional engineer to debug or service.

Pin 2: TXD. Pin3: RXD. Pin1/4: GND

### Dry Contact

IN+/GND	Input, passive signal. On: turn off battery. Off: normal.
Com/No1	Output1. On: stop charge.
Com/No2	Output2. On: stop discharge.
Com/No3	Output3. On: BMS error.

Output request signal voltage  $\leq 25V$

500 Kbps. 120 $\Omega$  recommended. For connection to LV-HUB, inverter.

9600 or 115200 bps. 120 $\Omega$  recommended. For connection to inverter.

### Link Port 0, 1

for communication between multiple parallel batteries.

## Definition of RJ45 Port Pin

	CAN	RS485
Pin1		RS485B
Pin2	GND	RS485A
Pin3		
Pin4	CAN H	
Pin5	CAN L	
Pin6		GND
Pin7		RS485A(recommend)
Pin8		RS485B(recommend)

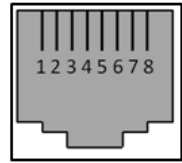

RJ45 Port

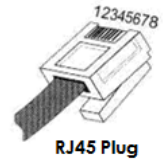

RJ45 Plug

## Power Terminals

Power cable terminals: there are two pair of terminals with same function, one connects to equipment, the other one paralleling to other battery module for capacity expanding.

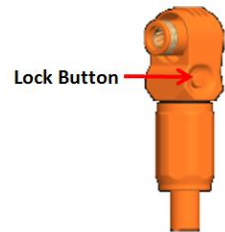





## Caution

Must keep pressing the “Lock Button” while pulling out the power plug.

*Vous devez continuer à appuyer sur le « Bouton de verrouillage » tout en retirant la fiche d'alimentation.*

## LED Status Indicators

Condition	RUN	ALR	1	2	3	4	5	6
Power off	-	-	-	-	-	-	-	-
Power on	●	●	●	●	●	●	●	●
Idle/Normal	■	-	-	-	-	-	-	-
Charge	●	-	Show soc; highest LED flash on: 0.5s; off 0.5s					
Discharge	■		Show soc					
Alarm	ALR: ●; Other LEDs are same as above.							
System error/Protect	-	●	-	-	-	-	-	
●/●	ON							
■	flash, on: 0.3s; off: 3.7s							
■/■	flash, on:0.5s; off: 1.5s							

## BMS basic function

Protection and alarm	Management and monitor
Charge/Discharge End	Cells Balance
Charge Over Voltage	Intelligent Charge Model
Discharge Under Voltage	Charge/Discharge Current Limit
Charge/Discharge Over Current	Capacity Retention Calculate
High/Low Temperature(cell/BMS)	Administrator Monitor
Short Circuit	Operation Record

### 3. Safe handling of lithium batteries guide

#### 3.1 Schematic diagram of solution

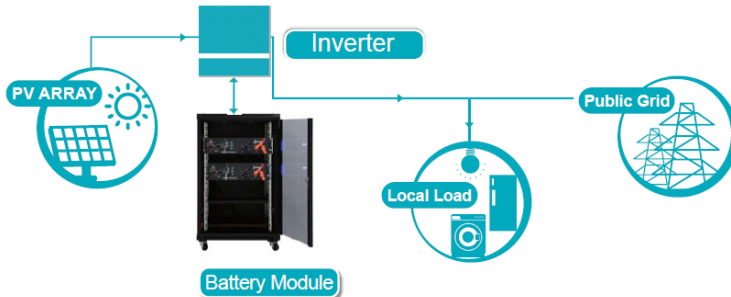

#### 3.2 Danger label

**DANGER**  
**DANGER LOW DC VOLTAGE INSIDE**  
**FAIBLE TENSION DE COURANT CONTINU À L'INTÉRIEUR**  
**DANGER ARC FLASH & SHOCK HAZARD**  
**DANGER D'ARC ÉLECTRIQUE ET DE RISQUE D'ÉLECTROCUTION**

- \* Do not disconnect, disassemble or repair by yourself.  
\* Ne pas débrancher, démonter ou réparer soi-même.
- \* Do not drop, deform, impact, cut or spearing with a sharp object.  
\* Ne pas échapper, déformer, frapper, couper ou transpercer avec un objet pointu.
- \* Do not place near open flame or incinerate.  
\* Ne pas placer près des flammes nues ou incinérer.
- \* Do not sit or put heavy things on battery.  
\* Ne pas s'asseoir ou mettre des objets lourds sur la batterie
- \* Keep away from moisture or liquid.  
\* Tenir loin de l'humidité ou de tout liquide.
- \* Keep out of reach of children, animals or insects.  
\* Garder hors de la portée des enfants, des animaux ou des insectes.
- \* Short circuit current rating / Courant de court-circuit : 300 A
- \* Maximum voltage / Tension maximale : 55V
- \* IP20

### 3.3 Tools



Wire cutter



Crimping modular plier



Screwdriver

#### NOTE

Use properly insulated tools to prevent accidental electric shock or short circuits. If insulated tools are not available, cover the entire exposed metal surfaces of the available tools, except their tips, with electrical tape.

### 3.4 Safety gear

It is recommended to wear the following safety gear when dealing with the battery pack



Insulated gloves



Safety goggles



Safety shoes

## 4. Installation and operation

### 4.1 Package items

Unpacking and check the Packing List

#### 1) For battery module package:

Two power cables and one communication cable for each battery package:

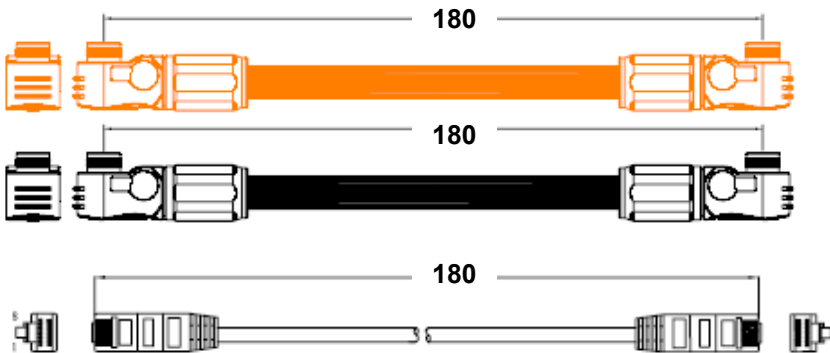

#### Grounding cable:



#### 2) For battery system connects to inverters:

Two long power cables (current capacity 120A, **constant 100A**) and one communication cable for each energy storage system:

#### NOTE

These three cables are belonging to External Cable Kit, **NOT** in battery package. They are in another extra small cable box. If there is anything missed please contact dealer.

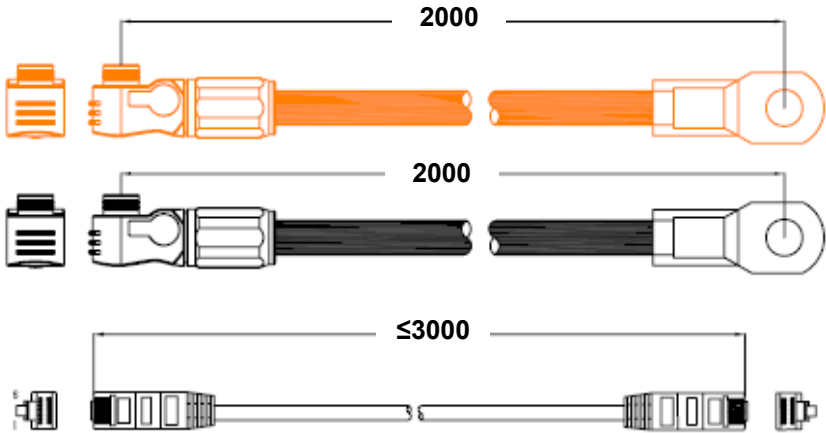

## 4.2 Installation location

Make sure that the installation location meets the following conditions:

- 1) The area is completely waterproof
- 2) The floor is flat and level.
- 3) There are no flammable or explosive materials.
- 4) The ambient temperature is within the range from 0°C to 50°C.
- 5) The temperature and humidity are maintained at a constant level.
- 6) There is minimal dust and dirt in the area.
- 7) The distance from heat source is more than 2 meters.
- 8) The distance from air outlet of inverter is more than 0.5 meters.
- 9) The installation areas shall avoid of direct sunlight.
- 10) There is no mandatory ventilation requirements for battery module, but please avoid of installation in confined area. The aeration shall avoid of high salinity, humidity or temperature.



### Caution

If the ambient temperature is outside the operating range, the battery pack stops operating to protect itself. The optimal temperature range for the battery pack to operate is 0°C to 50°C. Frequent exposure to harsh temperatures may deteriorate the performance and life of the battery pack.

*Si la température ambiante est hors de la plage de température de service, la batterie cesse de fonctionner pour se protéger.*

*La plage de température optimale pour la batterie est de 0°C à 50°C. Une exposition fréquente à des températures rigoureuses peut détériorer la performance et la durée de vie de la batterie*

### 4.3 Grounding

Grounding cables shall be 10AWG or higher yellow-green cables. After connection, the resistance from battery grounding point to Ground connection point of room or installed place shall smaller than 0.1Ω.

- 1) based on metal directly touch between the module's surface and rack's surface. If using painted rack the corresponding place shall remove the painting.
- 2) install a grounding cable to the grounding point of the modules.



#### Warning

Grounding is necessary.

*La mise à la terre est nécessaire.*

## 4.4 put into cabinet or racks

Put battery modules into cabinet and connect the cables:



- 1) Put the battery into the cabinet
- 2) Drive the 4 pcs screws
- 3) Connect the cables between battery modules
- 4) Connect the cables to inverter



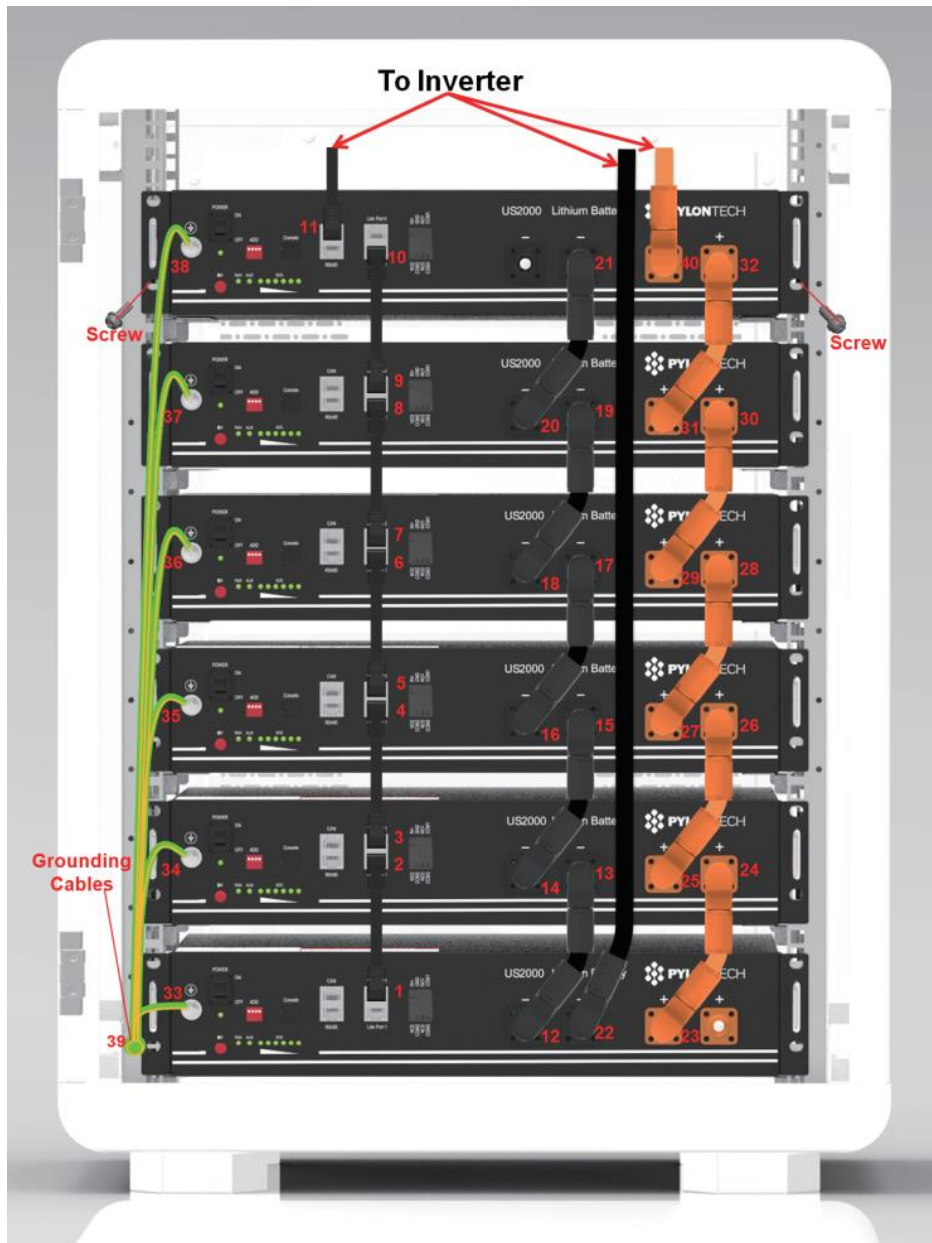

## 4.5 Put into bracket

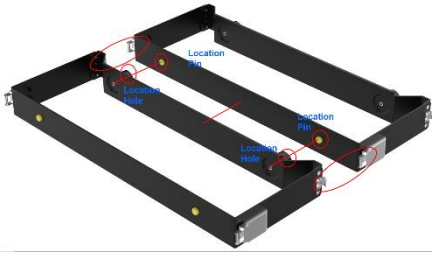

1) Dismantle the 2 holders of battery.



Dismantle 8 screws.

2) Put the battery into 2 pcs of bracket.

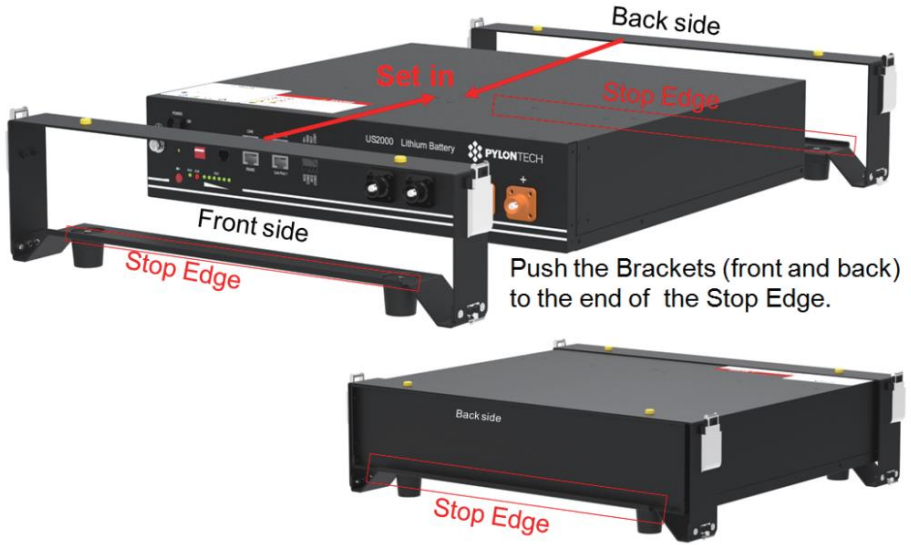

3) Use 4 location holes, stack the batteries together. And connect the 4 lockers together.



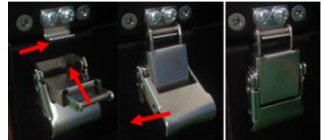

4) Maximum 4 in stack.



## NOTE

All the installation and operation must follow local electric standard.  
*L'installation et l'opération doivent respecter les normes électriques locales.*

**After installation, do not forget to register online for full warranty:**

<http://www.pylontech.com.cn/service/support>



### Warning

The power cables' current capacity is 120A max. If the battery string's design current over 100A, it must configure 2 pare external power cables to extend current capacity

*La capacité de courant des câbles d'alimentation est de 120 A. Si le courant de conception de la chaîne de batterie est supérieur à 100 A, il est nécessaire d'utiliser au moins 2 paires de câbles d'alimentation externes pour étendre la capacité de courant.*

There shall be a suitable manual disconnecting device (breaker, etc.) between battery system and inverter.

*Il faut y avoir un dispositif de déconnexion manuel approprié (disjoncteur, etc.) entre le système de batterie et l'onduleur*

## 4.6 power on

Double check all the power cable and communication cable.

1) Switch on all the battery modules:

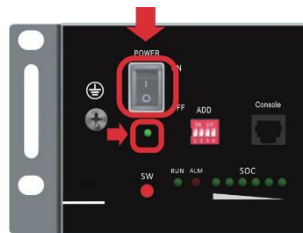

2) The one with **empty Link Port 0** is the **Master Battery** Module, others are slaves (1 master battery configure with maximum 7 slave batteries):

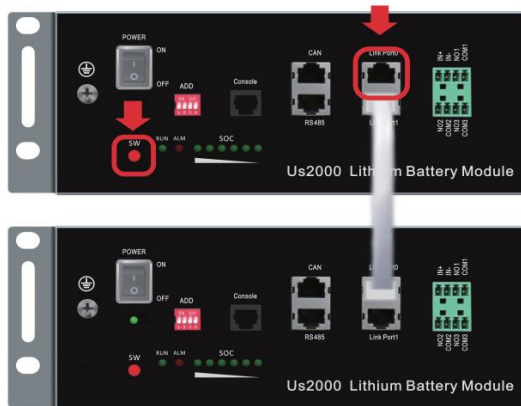

3) Press the **red SW button of master battery** to power on, all the battery LED light will be on one by one from the Master battery:



Note:

- 1) During capacity expansion or replacement, when parallel different SOC/voltage of module together, please maintain the system in idle for  $\geq 15$ mins or till the SOC LEDs becomes similar ( $\leq 1$ dot difference) before normal operation.

## **4.7 Power off**

- 1) Turn external power source off.
- 2) Press red SW switch of master battery. Then all batteries will off.
- 3) Switch Power switch OFF.

## **4.8 Multi-group mode**

By RS485: The interruption of each RS485 command shall at least  $\geq 1$ s





## Multiple Battery Groups CAN Communication Cable Connection

Each Communication HUB connects maximum 5 battery piles.  
to the inverter

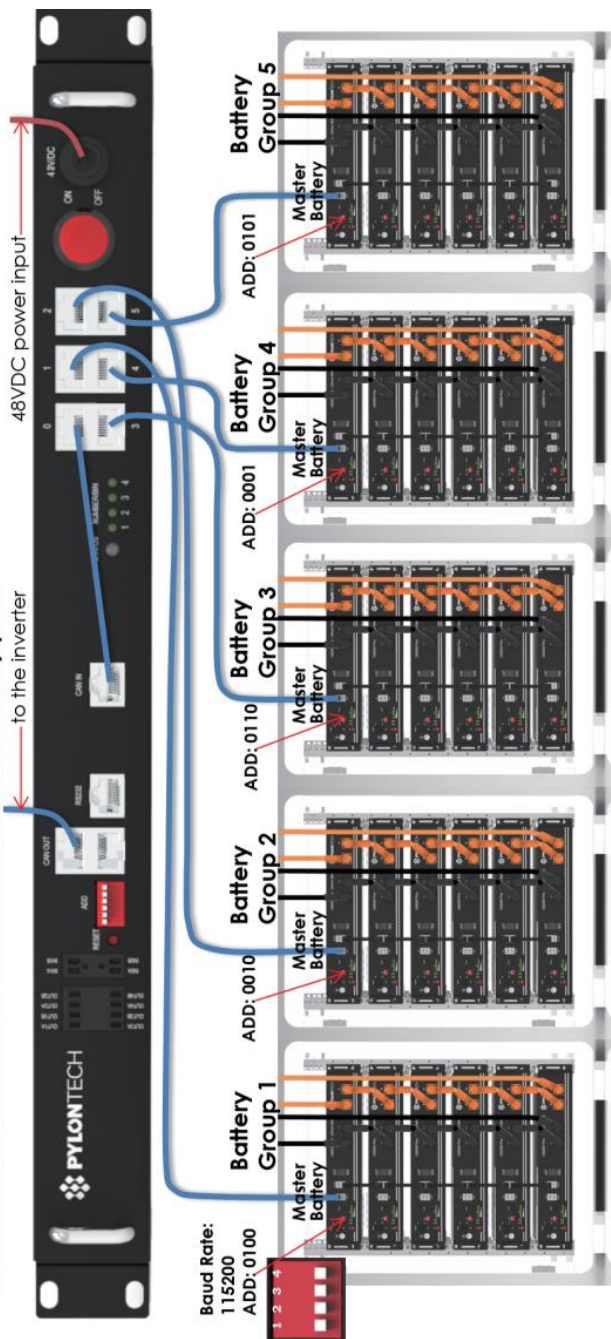

Each battery pile can configure maximum 8pcs US2000 or US3000.

## 5. Trouble shooting.

Problem determination based on

- 1) Whether the battery can be turned on or not
- 2) If battery is turned on, check the red light is off, flashing or lighting
- 3) If the red light is off, check whether the battery can be charged/discharged or not.

Possible conditions:

- 1) Battery cannot turn on, switch ON and press the red SW the lights are all no lighting or flashing.

- a) Capacity too low, or module over discharged.

solution: use a charge or inverter to provide 48-53.5V voltage. If battery can start, then keep charge the module and use monitor tools to check the battery log.

If battery terminal voltage is  $\leq 45\text{Vdc}$ , please use  $\leq 0.05\text{C}$  to slowly charge the module to avoid affect to SOH.

If battery terminal voltage is  $> 45\text{Vdc}$ , it can use  $\leq 0.5\text{C}$  to charge.

If battery cannot start, turn off battery and repair.

- 2) The battery can turn on, but red light is lighting, and cannot charge or discharge. If the red light is lighting, that means system is abnormal, please check values as following

- b) Temperature: Above  $60^\circ\text{C}$  or under  $-10^\circ\text{C}$ , the battery could not work.  
Solution: to move battery to the normal operating temperature range between  $0^\circ\text{C}$  and  $50^\circ\text{C}$

- c) Current: If current exceeds 90A, battery protection will turn on.

Solution: Check whether current is too large or not, if it is, change the settings on power supply side.

- d) High Voltage: If charging voltage above 54V, battery protection will turn on.  
Solution: Check whether voltage is too high or not, if it is, to change the settings on power supply side. And discharge the module.
  - e) Low Voltage: When the battery discharges to 44.5V or less, battery protection will turn on.  
Solution: Charge the battery till the red light turns off.
  - f) Cell voltage high. The module voltage is lower than 54V, SOC LED does not all on. When discharge the module protection disappear.  
Solution: keep charge the module by 53-54V or keep the system cycle. The BMS can balance the cell during cycling.
- 3) Unable to charge and discharge with red LED on. The temperature is 0~50 degree. Use charger to charge, not possible. Use load to discharge, not possible.
- g) Under permanent protection. The single cell voltage has been higher than 4.2 or lower than 1.5 or temperature higher than 80 degree. Solution: Switch off the module and contact your local distributor for repair.
- 4) Unable to charge and discharge without red LED on. The temperature is 0~50 degree. Use charger to charge, not possible. Use load to discharge, not possible.
- h) Fuse broken.  
Solution: Switch off the module and contact your local distributor for repair.



**NOTE:**

**Buzzers indicate high risk faulty condition**

- 5) Buzzer rings.
- i) MOSFAIL.  
Solution: Power off all battery and inverters. Disconnect breaker. Check the cable connection and disconnect all power cables. Check the power port damaged or not.

then try measure voltage of power port at turn off and turn on mode and remark the result. Switch off the module and contact your local distributor.

- 6) After switch On, the module turns on directly
- j) BMS failure.

Solution : Switch off the module and contact your local distributor.

**Excluding the points above, if the faulty is still cannot be located, turn off battery and repair.**

## **6. Emergency Situations**

### **1) Leaking Batteries**

If the battery pack leaks electrolyte, avoid contact with the leaking liquid or gas. If one is exposed to the leaked substance, immediately perform the actions described below.

- a) Inhalation: Evacuate the contaminated area and seek medical attention.
- b) Contact with eyes: Rinse eyes with flowing water for 15 minutes and seek medical attention.
- c) Contact with skin: Wash the affected area thoroughly with soap and water and seek medical attention.

Ingestion: Induce vomiting and seek medical attention.

### **2) Fire**

**NO WATER!** Only dry powder fire or carbon dioxide extinguisher can be used; if possible, move the battery pack to a safe area before it catches fire.

### **3) Wet Batteries**

If the battery pack is wet or submerged in water, do not let people access it, and then contact Pylontech or an authorized dealer for technical support. Cut off all power switch on inverter side.

### **4) Damaged Batteries**

Damaged batteries are dangerous and must be handled with the utmost

care. They are not fit for use and may pose a danger to people or property. If the battery pack seems to be damaged, pack it in its original container, and then return it to Pylontech or an authorized dealer.



**Danger**

Damaged batteries may leak electrolyte or produce flammable gas.

*Les batteries endommagées peuvent laisser fuir l'électrolyte ou produire un gaz inflammable.*

## 7. Remarks

### **Recycle and disposal**

In case a battery (normal condition or damaged) needs disposal or needs recycling, it shall follow the local recycling regulation to process, and using the best available techniques to achieve a relevant recycling efficiency.

### **Maintenance**

- 1) It is required to charge the battery at least once every 6 months, for this charge maintenance make sure the SOC is charged to higher than 90%
- 2) Every year after installation. The connection of power connector, grounding point, power cable and screw are suggested to be checked. Make sure there is no loose, no broken, no corrosion at connection point. Check the installation environment such as dust, water, insect etc. make sure it is suitable for IP20 battery system.
- 3) If the battery is stored for long time, it is required to charge them every six months, and the SOC should be higher than 90%





**PYLONTECH**

**Pylon Technologies Co., Ltd.**

No. 73, Lane 887, ZuChongzhi Road, Zhangjiang Hi-Tech Park  
Pudong, Shanghai 201203, China

**T**+86-21-51317699 | **F** +86-21-51317698

**E** [service@pylontech.com.cn](mailto:service@pylontech.com.cn)

**W** [www.pylontech.com.cn](http://www.pylontech.com.cn)